

SPECIFICATION

MECHANICAL:

- Housing Material: Polycarbonate, UL 94V-2. NO Poison
 UL 94V-0. NO Poison
- Material Contact: Brass / Phosphor Bronze.
- Gold Plating: FU" 2-3U" 3U" 6U" 15U" 30U"
 50U"
- Housing Color: Transparence.
- Operation Temperature: -10°C to 60°C.
- NO: P8-063-27

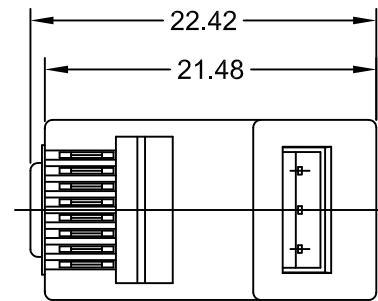
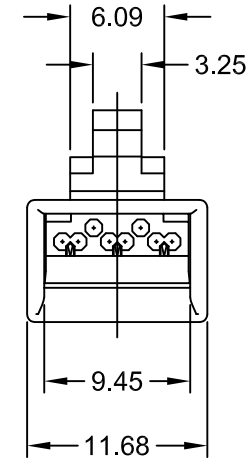
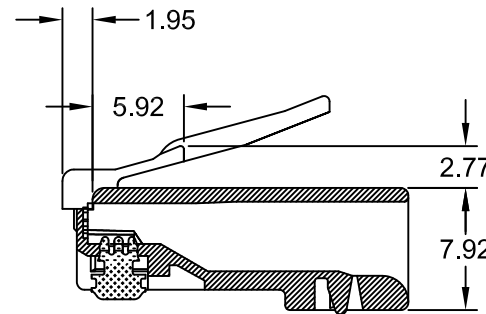
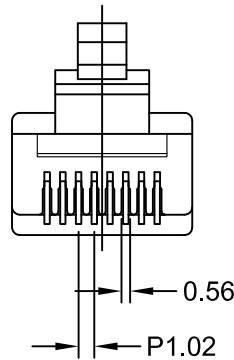
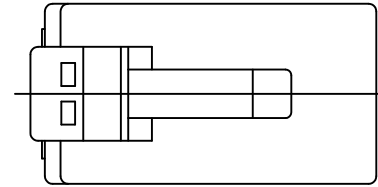
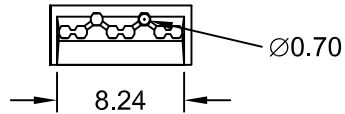
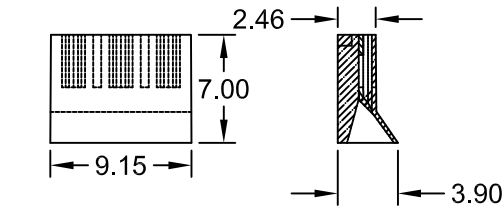

NOTE TOL: ±0.1

版本	A	繪圖	<i>Chicky</i>	日期	2012/9/4	品名	8P8C
3RD	⊕	核對	<i>Ivan</i>	日期	2020/8/21	規格	F-雙排斜度2.5二件式3.6長片 0.7mm支架 0.6專用線孔
單位	m/m	核准	<i>Jason</i>	日期	2020/8/21	圖號	
比例	1/1						

PMC 東莞普萊格通訊電子有限公司

PLUG MASTER INDUSTRIAL CO.,LTD

TEL: 86-769-87889195 FAX: 86-769-87889175